











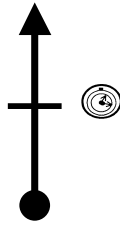

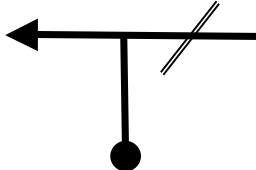
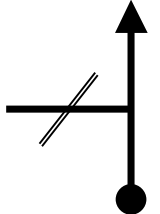
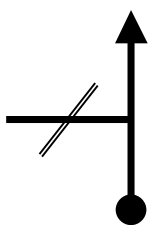
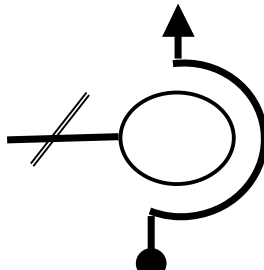
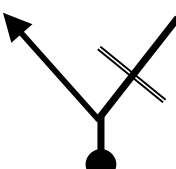
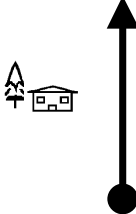
SETTORE SECTEUR		C.O.		DISTANZA KM	MEDIA	
1		1 LURISIA		0,550	33,00	
		C.O.		TEMPO IMPOSTO	0.01.00	
		2 PALATERME		TEMPS IMPARTI		
DISTANZA / DISTANCE			DIREZIONE / DIRECTION		INFORMAZIONI INFORMATIONS	
TOT.	PARZ.				KM REGRESS.	
0,00	0,00	1			C.O. 1 PARTENZA H. Everest	0,55
0,06	0,06	2				0,49
0,48	0,42	3				0,07
0,55	0,07	4			PALATERME C.O. 2 C.O. 3 120 mt	0,00

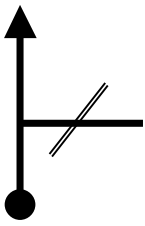
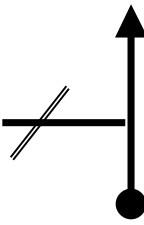
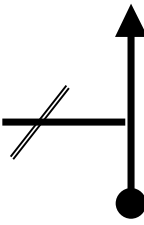
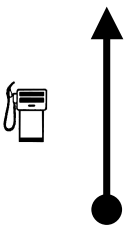

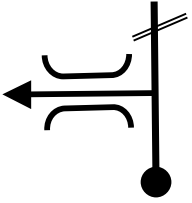
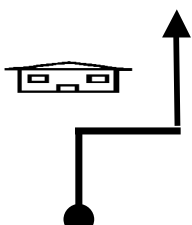

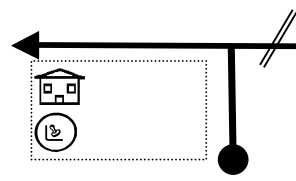
SETTORE SECTEUR		C.O.		DISTANZA KM	MEDIA
2		3 PALATERME		0,990	29,70
		C.O.		TEMPO IMPOSTO	
		4 Fine Zindo Vigliani		TEMPS IMPARTI	0.02.00
DISTANZA / DISTANCE			DIREZIONE / DIRECTION	INFORMAZIONI INFORMATIONS	KM REGRESS.
TOT.	PARZ.				
0,00	0,00	5		 C.O. 3	0,99
0,07	0,07	6			0,92
0,15	0,08	7		Via Zindo Vigliani	0,84
0,65	0,50	8		!! STRETTOIA	0,34
0,99	0,34	9		 C.O. 4  C.O. 5 40 mt.	0,00

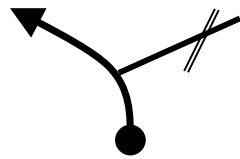
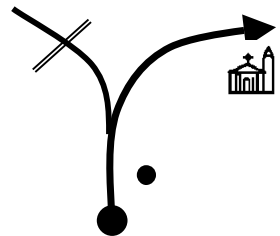
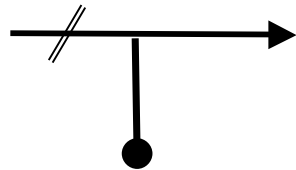
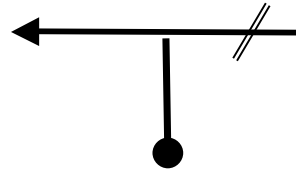
SETTORE SECTEUR		C.O.		DISTANZA KM	MEDIA
3		5 Fine Zindo Vigliani		9,730	22,76
		C.O.		TEMPO IMPOSTO	0.25.39
		6 Fontana Nata		TEMPS IMPARTI	
DISTANZA / DISTANCE			INFORMAZIONI INFORMATIONS		KM REGRESS.
TOT.	PARZ.	DIREZIONE / DIRECTION			
0,00	0,00	10			9,73
0,01	0,01	11			9,72
0,09	0,08	12		CHIUSA PESIO Via Barisone	9,64
0,20	0,11	13		H. EVEREST 	9,53
1,08	0,88	14		TERME	8,65
1,88	0,80	15		CHIUSA PESIO CUNEO Mondovi	7,85



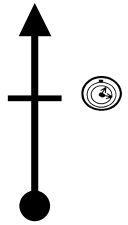

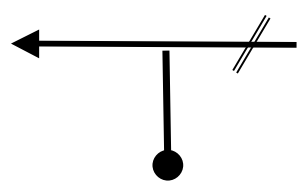
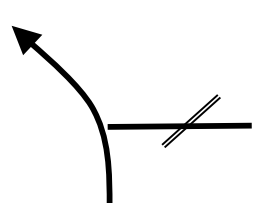

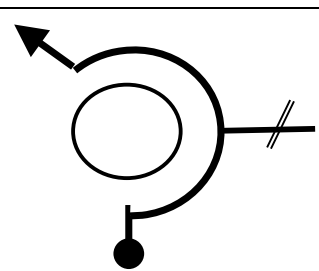
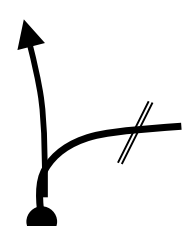

SETTORE SECTEUR		C.O.		DISTANZA KM	MEDIA
3		5 Fine Zindo Vigliani		9,730	22,76
		C.O.		TEMPO IMPOSTO	0.25.39
		6 Fontana Nata		TEMPS IMPARTI	
DISTANZA / DISTANCE		DIREZIONE / DIRECTION		INFORMAZIONI INFORMATIONS	KM REGRESS.
TOT.	PARZ.				
3,92	2,04	16		 CAMPEGGIO PIAN BOSCO	5,81
4,22	0,30	17		!! ATTENZIONE USCITA CONCORRENTI	5,51
5,23	1,01	18		Chiusa Pesio	4,50
5,41	0,18	19			4,32
5,73	0,32	20		 Distributore TOTAL	4,00
5,99	0,26	21		CHIUSA PESIO	3,74

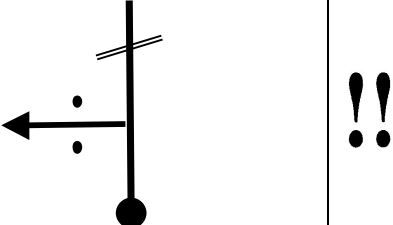
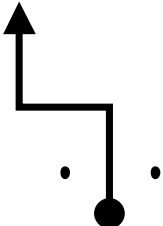
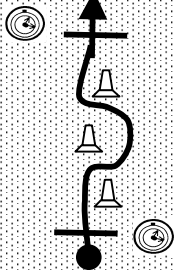

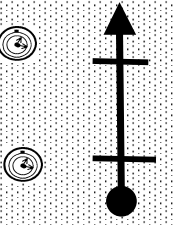
SETTORE SECTEUR		C.O.		DISTANZA KM	MEDIA
3		5 Fine Zindo Vigliani		9,730	22,76
		C.O.		TEMPO IMPOSTO	0.25.39
		6 Fontana Nata		TEMPS IMPARTI	
DISTANZA / DISTANCE		DIREZIONE / DIRECTION		INFORMAZIONI INFORMATIONS	KM REGRESS.
TOT.	PARZ.				
6,14	0,15	22		 COMUNE	3,59
6,22	0,08	23		Piazza Cavour  C.T.  Bar Carillon Controllo a timbro	3,51
6,34	0,12	24		Via Vallauri	3,39
6,49	0,15	25		● Fontana	3,24
6,61	0,12	26		Via Parrocchia Vecchia	3,12
6,75	0,14	27		Via Paschero	2,98

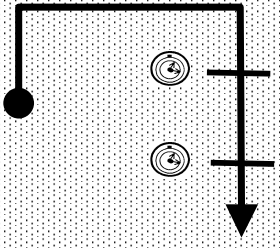

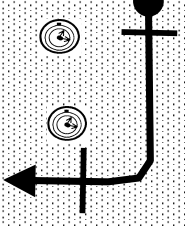

SETTORE SECTEUR		C.O.		DISTANZA KM	MEDIA
3		5 Fine Zindo Vigliani		9,730	22,76
		C.O.		TEMPO IMPOSTO	0.25.39
		6 Fontana Nata		TEMPS IMPARTI	
DISTANZA / DISTANCE		DIREZIONE / DIRECTION		INFORMAZIONI INFORMATIONS	KM REGRESS.
TOT.	PARZ.				
6,80	0,05	28		Cimitero	2,93
7,50	0,70	29			2,23
7,57	0,07	30			2,16
8,36	0,79	31		MONDOVI' PIANFEI	1,37
9,63	1,27	32		SP1 Via Fontana Nata	0,10
9,73	0,10	33		Fontana Nata C.O. 6 C.O. 7 60 mt.	0,00

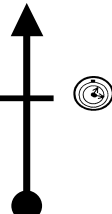
SETTORE SECTEUR		C.O.		DISTANZA KM	MEDIA
5		9 Fine Mortè		10,200	17,49
		C.O.		TEMPO IMPOSTO TEMPS IMPARTI	0.35.00
DISTANZA / DISTANCE		DIREZIONE / DIRECTION		INFORMAZIONI INFORMATIONS	KM REGRESS.
TOT.	PARZ.				
0,00	0,00	37			10,20
0,08	0,08	38		MONDOVI'	10,12
2,38	2,30	39		Lurisia	7,82
4,18	1,80	40		Roccaforte Mondovì	6,02
4,68	0,50	41		Prea	5,52
4,75	0,07	42		Roccaforte Centro	5,45
PAG.					8

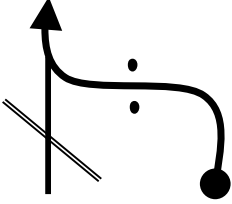
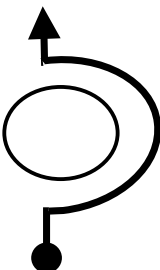
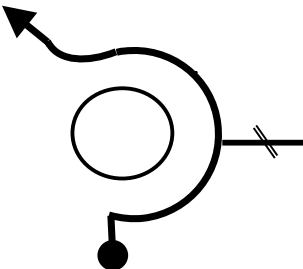
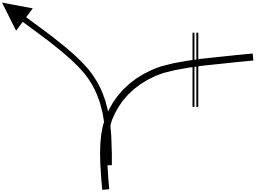
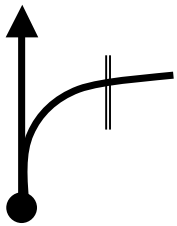

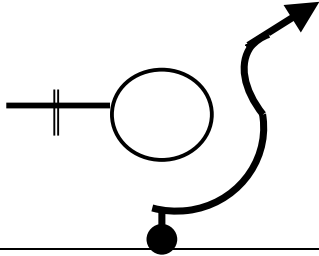
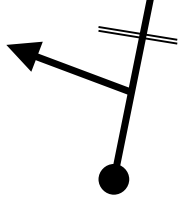
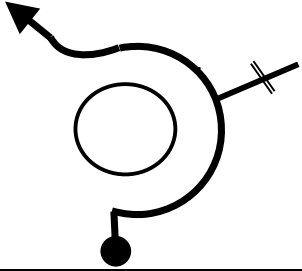
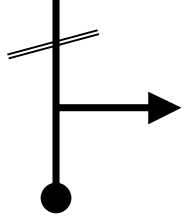
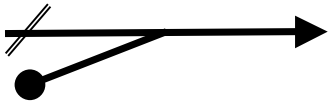
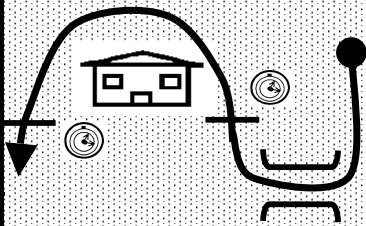
SETTORE SECTEUR		C.O.		DISTANZA KM	MEDIA
5		9 Fine Mortè		10,200	17,49
		C.O.		TEMPO IMPOSTO TEMPS IMPARTI	0.35.00
DISTANZA / DISTANCE		DIREZIONE / DIRECTION		INFORMAZIONI INFORMATIONS	KM REGRESS.
TOT.	PARZ.				
6,86	2,11	43		Villanova Via Valje	3,34
7,92	1,06	44		Via Cave	2,28
8,42	0,50	45		Via Marconi	1,78
8,72	0,30	46		MONDOVI'	1,48
8,82	0,10	47		MONDOVI'	1,38
9,98	1,16	48		Bar Terranova Aperitivo C.T. Controllo a timbro	0,22



SETTORE SECTEUR		C.O.		DISTANZA KM	MEDIA
5		9 Fine Mortè		10,200	17,49
		C.O.		TEMPO IMPOSTO TEMPS IMPARTI	0.35.00
DISTANZA / DISTANCE		DIREZIONE / DIRECTION		INFORMAZIONI INFORMATIONS	KM REGRESS.
TOT.	PARZ.				
10,00	0,02	49		ZONA INDUSTRIALE	0,20
10,10	0,10	50		Via Forzani	0,10
10,20	0,10	51		 C.O.10  C.O.11 100 mt.	0,00
		52		 C.O. 12 70 mt.  C.O. 13 70mt.	
		53		 C.O.14 190 mt.  C.O.15 90 mt.	
		54		 C.O. 16 90 mt.  C.O. 17 90mt.	
PAG.					10



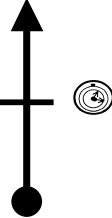

SETTORE SECTEUR		C.O.		DISTANZA KM	MEDIA
6		17 Villanova M.vì		10,030	32,68
		C.O.		TEMPO IMPOSTO TEMPS IMPARTI	0.18.25
DISTANZA / DISTANCE		DIREZIONE / DIRECTION		INFORMAZIONI INFORMATIONS	KM REGRESS.
TOT.	PARZ.				
0,00	0,00	55		 C.O. 17	10,03
0,05	0,05	56			9,98
1,18	1,13	57			8,85
1,27	0,09	58		Pianfer Cuneo CHIUSA PESIO	8,76
1,62	0,35	59		LURISIA	8,41
3,54	1,92	60		S / Lucia	6,49
PAG.					11

SETTORE SECTEUR		C.O.		DISTANZA KM	MEDIA
6		17 Villanova M.vì		10,030	32,68
		18 Lurisia - Pala Terme		TEMPO IMPOSTO TEMPS IMPARTI	0.18.25
DISTANZA / DISTANCE			INFORMAZIONI INFORMATIONS		KM REGRESS.
TOT.	PARZ.	DIREZIONE / DIRECTION			
5,38	1,84	61		Praga LURISIA	4,65
7,68	2,30	62		!! LURISIA TERME	2,35
8,45	0,77	63		LURISIA	1,58
9,36	0,91	64		H. EVEREST Pattinaggio su ghiaccio	0,67
9,54	0,18	65		!!	0,49
10,03	0,49	66		 PALATERME  C.O. 18  C.O. 19 120 mt	0,00
PAG.					12

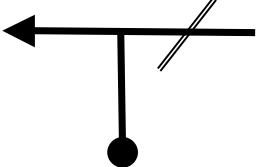
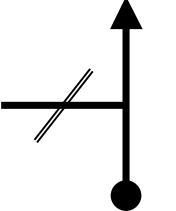
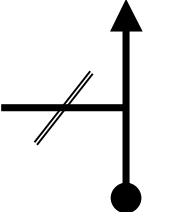
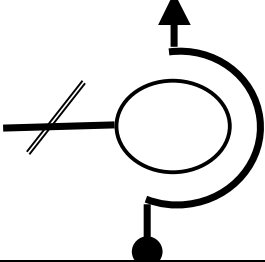
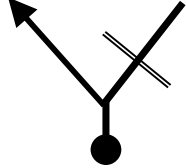
SETTORE SECTEUR 7	C.O. 19 PALATERME	DISTANZA KM 0,990	MEDIA 29,70
	C.O. 20 Fine Zindo Vigliani	TEMPO IMPOSTO TEMPS IMPARTI	0.02.00

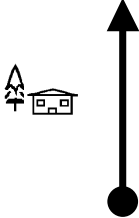
DISTANZA / DISTANCE			DIREZIONE / DIRECTION	INFORMAZIONI INFORMATIONS	KM REGRESS.
TOT.	PARZ.				
0,00	0,00	65		 C.O. 19	0,99
0,07	0,07	66			0,92
0,15	0,08	67		Via Zindo Vigliani	0,84
0,65	0,50	68		!! STRETTOIA	0,34
0,99	0,34	69		 C.O. 20  C.O. 21 40 mt.	0,00

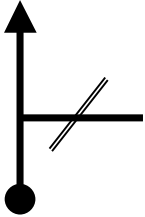
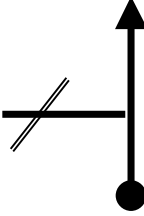
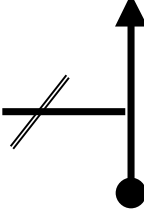
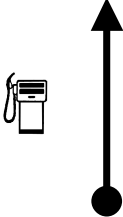

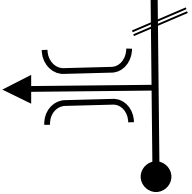

SETTORE SECTEUR		C.O.		DISTANZA KM	MEDIA
8		21 Fine Zindo Vigliani		9,730	22,58
		C.O.		TEMPO IMPOSTO	0.25.51
		22 Fontana Nata		TEMPS IMPARTI	
DISTANZA / DISTANCE			INFORMAZIONI INFORMATIONS		KM REGRESS.
TOT.	PARZ.	DIREZIONE / DIRECTION			
0,00	0,00	70		 C.O. 21	9,73
0,01	0,01	71			9,72
0,09	0,08	72		CHIUSA PESIO Via Barisone	9,64
0,20	0,11	73		H. EVEREST	9,53
1,08	0,88	74		TERME	8,65
1,88	0,80	75		CHIUSA PESIO CUNEO Mondovi	7,85





SETTORE SECTEUR		C.O.		DISTANZA KM	MEDIA
8		21 Fine Zindo Vigliani		9,730	22,58
		C.O.		TEMPO IMPOSTO TEMPS IMPARTI	0.25.51
DISTANZA / DISTANCE		DIREZIONE / DIRECTION		INFORMAZIONI INFORMATIONS	KM REGRESS.
TOT.	PARZ.				
3,92	2,04	76		 CAMPEGGIO PIAN BOSCO	5,81
4,22	0,30	77		!! ATTENZIONE USCITA CONCORRENTI	5,51
5,23	1,01	78		Chiusa Pesio	4,50
5,41	0,18	79			4,32
5,73	0,32	80		 Distributore TOTAL	4,00
5,99	0,26	81		CHIUSA PESIO	3,74

SETTORE SECTEUR		C.O.		DISTANZA KM	MEDIA
8		21 Fine Zindo Vigliani		9,730	22,58
		C.O.		TEMPO IMPOSTO TEMPS IMPARTI	0.25.51
DISTANZA / DISTANCE		DIREZIONE / DIRECTION		INFORMAZIONI INFORMATIONS	KM REGRESS.
TOT.	PARZ.				
6,14	0,15	82		 COMUNE	3,59
6,22	0,08	83		Piazza Cavour C.T. Bar Carillon Controllo a timbro	3,51
6,34	0,12	84		Via Vallauri	3,39
6,49	0,15	85		● Fontana	3,24
6,61	0,12	86		Via Parrocchia Vecchia	3,12
6,75	0,14	87		Via Paschero	2,98



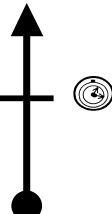

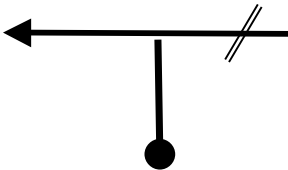
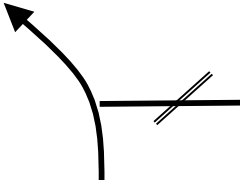

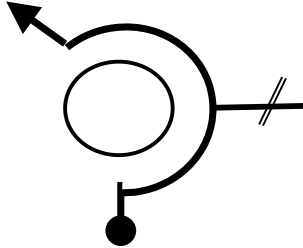
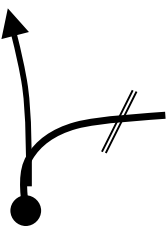

SETTORE SECTEUR		C.O.		DISTANZA KM	MEDIA
8		21 Fine Zindo Vigliani		9,730	22,58
		C.O.		TEMPO IMPOSTO	0.25.51
		22 Fontana Nata		TEMPS IMPARTI	
DISTANZA / DISTANCE			INFORMAZIONI INFORMATIONS		KM REGRESS.
TOT.	PARZ.	DIREZIONE / DIRECTION			
6,80	0,05	88		Cimitero	2,93
7,50	0,70	89			2,23
7,57	0,07	90			2,16
8,36	0,79	91		MONDOVI' PIANFEI	1,37
9,63	1,27	92		SP1 Via Fontana Nata	0,10
9,73	0,10	93		Fontana Nata C.O. 22 C.O. 23 60 mt.	0,00

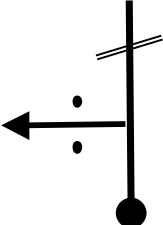
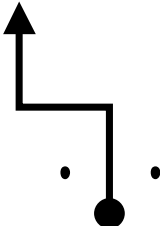
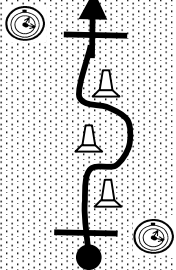

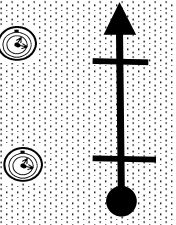
SETTORE SECTEUR 9	C.O. 23 Fontana Nata	DISTANZA KM 4,410	MEDIA 39,20
	C.O. 24 Fine Mortè	TEMPO IMPOSTO TEMPS IMPARTI	0.06.45

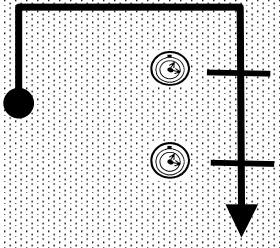

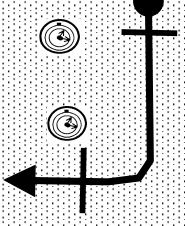

DISTANZA / DISTANCE			DIREZIONE / DIRECTION	INFORMAZIONI INFORMATIONS	KM REGRESS.
TOT.	PARZ.				
0,00	0,00	94		 C.O. 23	4,41
2,21	2,21	95		 ATTENZIONE SALTO	2,20
4,41	2,20	96		 C.O. 24  C.O. 25 80 mt.	0,00
		<input type="checkbox"/>			
		<input type="checkbox"/>			
		<input type="checkbox"/>			

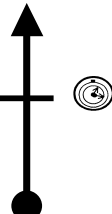
SETTORE SECTEUR		C.O.		DISTANZA KM	MEDIA
10		25 Fine Mortè		10,200	17,49
		C.O.		TEMPO IMPOSTO TEMPS IMPARTI	0.35.00
DISTANZA / DISTANCE		DIREZIONE / DIRECTION		INFORMAZIONI INFORMATIONS	KM REGRESS.
TOT.	PARZ.				
0,00	0,00	97			10,20
0,08	0,08	98		MONDOVI'	10,12
2,38	2,30	99		Lurisia	7,82
4,18	1,80	100		Roccaforte Mondovì	6,02
4,68	0,50	101		Prea	5,52
4,75	0,07	102		Roccaforte Centro	5,45

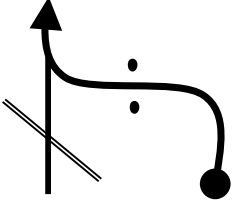
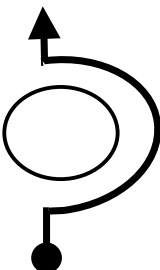
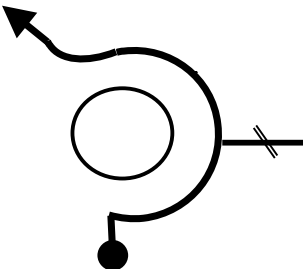
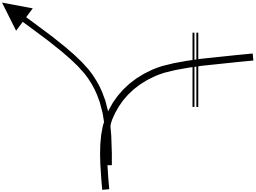
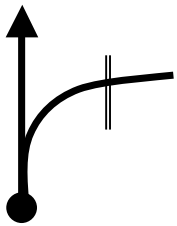

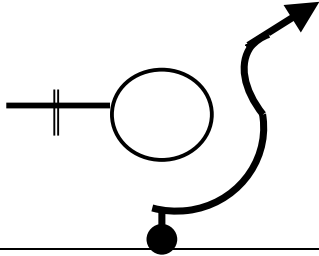
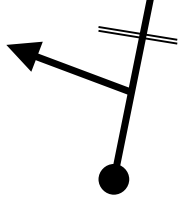
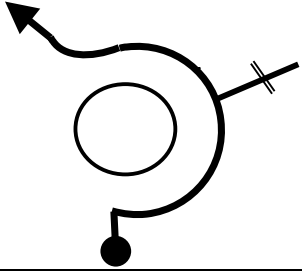
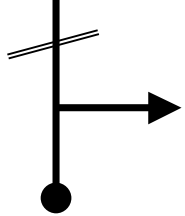
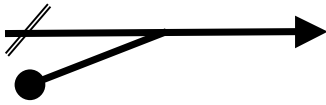
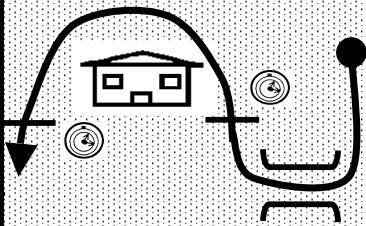
SETTORE SECTEUR 10		C.O. 25 Fine Mortè		DISTANZA KM 10,200	MEDIA 17,49
		C.O. 26 VILLANOVA M.vì		TEMPO IMPOSTO TEMPS IMPARTI	0.35.00
DISTANZA / DISTANCE			INFORMAZIONI INFORMATIONS		KM REGRESS.
TOT.	PARZ.	DIREZIONE / DIRECTION			
6,86	2,11	103		Villanova Via Valye	3,34
7,92	1,06	104		Via Cave	2,28
8,42	0,50	105		Via Marconi	1,78
8,72	0,30	106		MONDOVI'	1,48
8,82	0,10	107		MONDOVI'	1,38
9,98	1,16	108		Bar Terranova C.T. Controllo a timbro	0,22



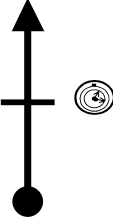

SETTORE SECTEUR		C.O.		DISTANZA KM	MEDIA	
10		25 Fine Mortè		10,200	17,49	
		C.O.		TEMPO IMPOSTO TEMPS IMPARTI	0.35.00	
DISTANZA / DISTANCE		DIREZIONE / DIRECTION		INFORMAZIONI INFORMATIONS	KM REGRESS.	
TOT.	PARZ.					
10,00	0,02	109		!!	ZONA INDUSTRIALE	0,20
10,10	0,10	110			Via Forzani	0,10
10,20	0,10	111			 C.O.26  C.O.27 100 mt.	0,00
		112			 C.O. 28 70 mt.  C.O. 29 70mt.	
		113			 C.O.30 190 mt.  C.O.31 90 mt.	
		114			 C.O.32 90 mt.  C.O.33 90mt.	
PAG.					21	

SETTORE SECTEUR		C.O.		DISTANZA KM	MEDIA
11		33 Villanova M.vì		10,030	32,68
		C.O.		TEMPO IMPOSTO TEMPS IMPARTI	0.18.25
DISTANZA / DISTANCE		DIREZIONE / DIRECTION		INFORMAZIONI INFORMATIONS	KM REGRESS.
TOT.	PARZ.				
0,00	0,00	115		 C.O. 33	10,03
0,05	0,05	116			9,98
1,18	1,13	117			8,85
1,27	0,09	118		Pianfer Cuneo CHIUSA PESIO	8,76
1,62	0,35	119		LURISIA	8,41
3,54	1,92	120		S/ Lucia	6,49

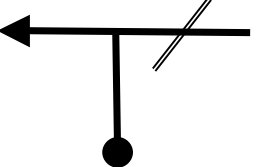
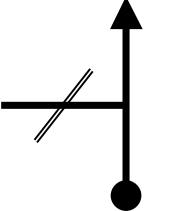
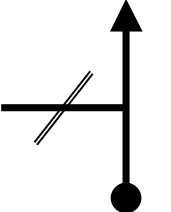
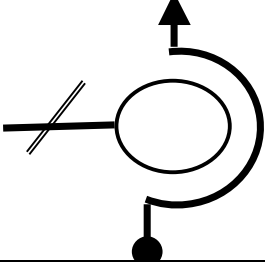
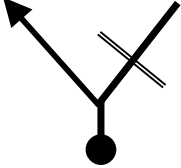

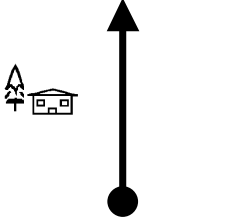

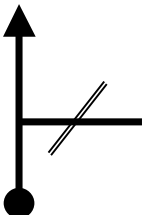
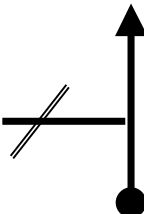
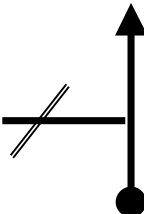
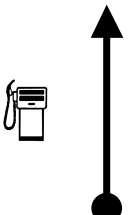

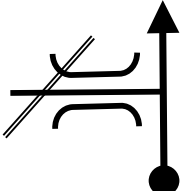
SETTORE SECTEUR		C.O.		DISTANZA KM	MEDIA
11		33 Villanova M.vì		10,030	32,68
		34 Lurisia - Pala Terme		TEMPO IMPOSTO TEMPS IMPARTI	0.18.25
DISTANZA / DISTANCE			INFORMAZIONI INFORMATIONS		KM REGRESS.
TOT.	PARZ.	DIREZIONE / DIRECTION			
5,38	1,84	121		Praga LURISIA	4,65
7,68	2,30	122		!! LURISIA TERME	2,35
8,45	0,77	123		LURISIA	1,58
9,36	0,91	124		H. EVEREST Pattinaggio su ghiaccio	0,67
9,54	0,18	125		!!	0,49
10,03	0,49	126		 PALATERME  C.O. 34  C.O. 35 120 mt	0,00
PAG.					23

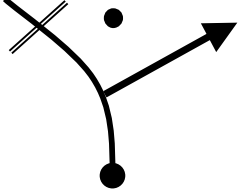
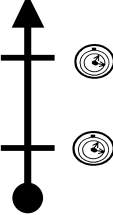

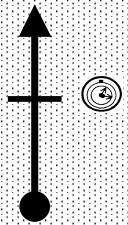

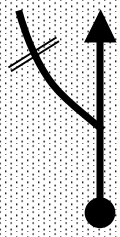
SETTORE SECTEUR		C.O.		DISTANZA KM	MEDIA
12		35 PALATERME		0,990	29,70
		C.O.		TEMPO IMPOSTO TEMPS IMPARTI	0.02.00
DISTANZA / DISTANCE		DIREZIONE / DIRECTION		INFORMAZIONI INFORMATIONS	KM REGRESS.
TOT.	PARZ.				
0,00	0,00	125		C.O. 35	0,99
0,07	0,07	126			0,92
0,15	0,08	127		Via Zindo Viglioni	0,84
0,65	0,50	128		!! STRETTOIA	0,34
0,99	0,34	129		C.O. 36 C.O. 37 40 mt.	0,00

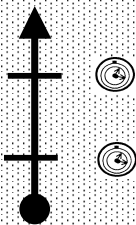
SETTORE SECTEUR 13		C.O. 37 Fine Zindo Vigliani		DISTANZA KM 7,960	MEDIA 30,13
		C.O. 38 Fontana Nata		TEMPO IMPOSTO TEMPS IMPARTI	0.15.51
DISTANZA / DISTANCE			INFORMAZIONI INFORMATIONS		KM REGRESS.
TOT.	PARZ.	DIREZIONE / DIRECTION			
0,00	0,00	130		 C.O. 37	7,96
0,01	0,01	131			7,95
0,09	0,08	132		CHIUSA PESIO Via Barisone	7,87
0,20	0,11	133		H. EVEREST	7,76
1,08	0,88	134		TERME	6,88
1,88	0,80	135		CHIUSA PESIO CUNEO Mondovi	6,08



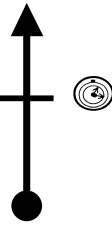

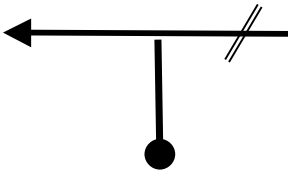
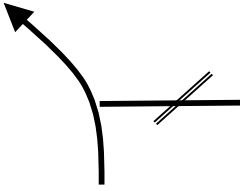

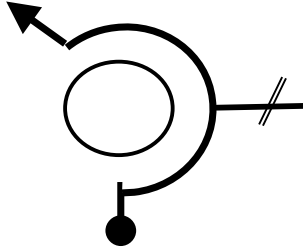
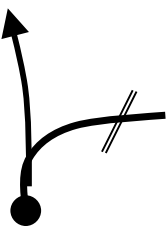

SETTORE SECTEUR 13		C.O. 37 Fine Zindo Vigliani		DISTANZA KM 7,960	MEDIA 30,13
		C.O. 38 Fontana Nata		TEMPO IMPOSTO TEMPS IMPARTI	0.15.51
DISTANZA / DISTANCE			INFORMAZIONI INFORMATIONS		KM REGRESS.
TOT.	PARZ.	DIREZIONE / DIRECTION			
3,92	2,04	136		 CAMPEGGIO PIAN BOSCO	4,04
4,22	0,30	137		!! ATTENZIONE USCITA CONCORRENTI	3,74
5,23	1,01	138		Chiusa Pesio	2,73
5,41	0,18	139			2,55
5,73	0,32	140		 Distributore TOTAL	2,23
5,99	0,26	141		!! PIANFEI CHIUSA PESIO	1,97
PAG.					26

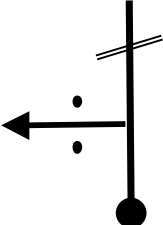
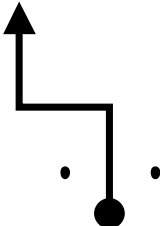
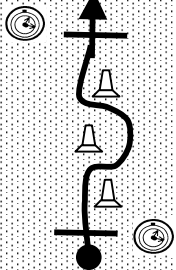

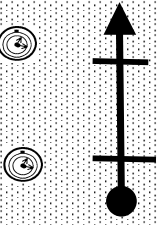
SETTORE SECTEUR		C.O.		DISTANZA KM	MEDIA
13		37 Fine Zindo Vigliani		7,960	30,13
		C.O.		TEMPO IMPOSTO	0.15.51
		38 Fontana Nata		TEMPS IMPARTI	
DISTANZA / DISTANCE			INFORMAZIONI INFORMATIONS		KM REGRESS.
TOT.	PARZ.	DIREZIONE / DIRECTION			
7,26	1,27	<input type="text" value="142"/>		!!	SP1 Via Fontana Nata 0,70
7,96	0,70	<input type="text" value="143"/>			Fontana Nata C.O. 38 C.O. 39 60 mt. 0,00
		<input type="text" value=""/>			
		<input type="text" value=""/>			
		<input type="text" value=""/>			
		<input type="text" value=""/>			
		<input type="text" value=""/>			
PAG.					27

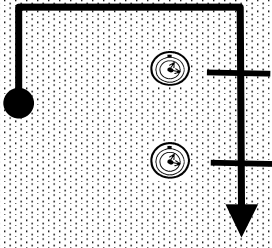
SETTORE SECTEUR		C.O.		DISTANZA KM	MEDIA
14		39 Fontana Nata		4,410	39,20
		C.O.		TEMPO IMPOSTO TEMPS IMPARTI	0.06.45
DISTANZA / DISTANCE		DIREZIONE / DIRECTION		INFORMAZIONI INFORMATIONS	KM REGRESS.
TOT.	PARZ.				
0,00	0,00	1		 C.O. 39	4,41
2,21	2,21	2		 ATTENZIONE SALTO	2,20
4,41	2,20	3		 C.O. 40  C.O. 41 80 mt.	0,00

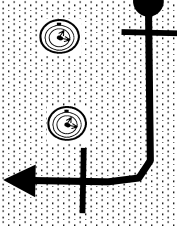
SETTORE SECTEUR		C.O.		DISTANZA KM	MEDIA
15		41 Fine Mortè		10,200	24,48
		C.O.		TEMPO IMPOSTO TEMPS IMPARTI	0.25.00
DISTANZA / DISTANCE		DIREZIONE / DIRECTION		INFORMAZIONI INFORMATIONS	KM REGRESS.
TOT.	PARZ.				
0,00	0,00	4			10,20
0,08	0,08	5		MONDOVI'	10,12
2,38	2,30	6		Lurisia	7,82
4,18	1,80	7		Roccaforte Mondovì	6,02
4,68	0,50	8		Prea	5,52
4,75	0,07	9		Roccaforte Centro	5,45

SETTORE SECTEUR		C.O.		DISTANZA KM	MEDIA
15		41 Fine Mortè		10,200	24,48
		C.O.		TEMPO IMPOSTO TEMPS IMPARTI	0.25.00
DISTANZA / DISTANCE		DIREZIONE / DIRECTION		INFORMAZIONI INFORMATIONS	KM REGRESS.
TOT.	PARZ.				
6,86	2,11	10		Villanova Via Valye	3,34
7,92	1,06	11		Via Cave	2,28
8,42	0,50	12		Via Marconi	1,78
8,72	0,30	13		MONDOVI'	1,48
8,82	0,10	14		MONDOVI'	1,38
9,98	1,16	15		Bar Terranova C.T. Controllo a timbro	0,22

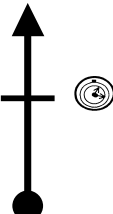
SETTORE SECTEUR		C.O.		DISTANZA KM	MEDIA	
15		41 Fine Mortè		10,200	24,48	
		C.O.		TEMPO IMPOSTO TEMPS IMPARTI	0.25.00	
DISTANZA / DISTANCE		DIREZIONE / DIRECTION		INFORMAZIONI INFORMATIONS	KM REGRESS.	
TOT.	PARZ.					
10,00	0,02	16		!!	ZONA INDUSTRIALE	0,20
10,10	0,10	17			Via Forzani	0,10
10,20	0,10	18			 C.O.42  C.O.43 100 mt.	0,00
		19			 C.O. 44 70 mt.  C.O. 45 70mt.	
		20			 C.O.46 190 mt.  C.O.47 90 mt.	
		21			 C.O.48 90 mt.  C.O.49 90mt.	
PAG.					31	

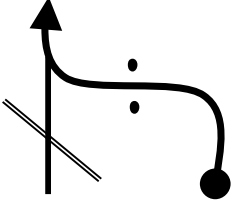
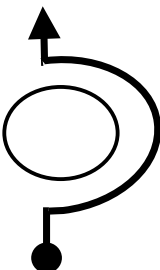
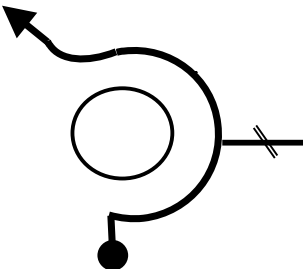
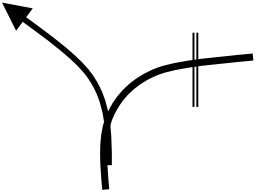
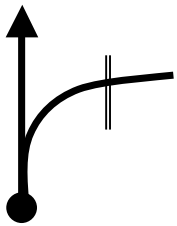
SETTORE SECTEUR		C.O.		DISTANZA KM	MEDIA
16		49 Villanova M.vì		9,770	33,28
		C.O.		TEMPO IMPOSTO TEMPS IMPARTI	0.17.37
DISTANZA / DISTANCE		DIREZIONE / DIRECTION		INFORMAZIONI INFORMATIONS	KM REGRESS.
TOT.	PARZ.				
0,00	0,00	22		 C.O. 49	9,77
0,05	0,05	23			9,72
1,18	1,13	24			8,59
1,27	0,09	25		Pianfer Cuneo CHIUSA PESIO	8,50
1,62	0,35	26		LURISIA	8,15
3,54	1,92	27		S/Lucia	6,23

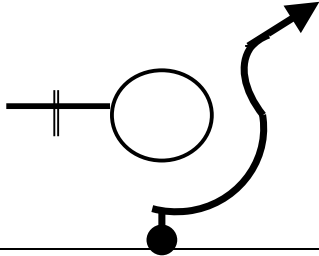
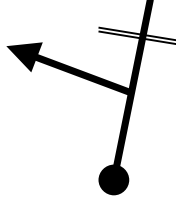
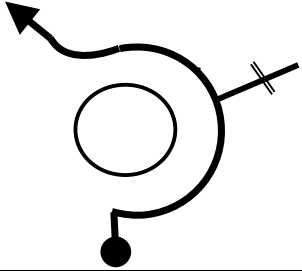
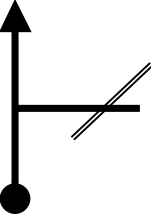
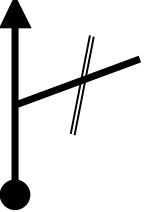
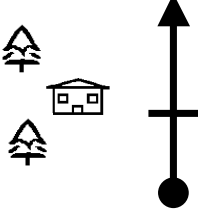
SETTORE SECTEUR		C.O.		DISTANZA KM	MEDIA
16		49 Villanova M.vì		9,770	33,28
		C.O.		TEMPO IMPOSTO TEMPS IMPARTI	
		50 Lurisia - Centro Ippico			0.17.37
DISTANZA / DISTANCE			INFORMAZIONI INFORMATIONS		KM REGRESS.
TOT.	PARZ.	DIREZIONE / DIRECTION			
5,38	1,84	28		Praga LURISIA	4,39
7,68	2,30	29		!! LURISIA TERME	2,09
8,45	0,77	30		LURISIA	1,32
9,36	0,91	31		H. EVEREST	0,41
9,47	0,11	32			0,30
9,77	0,30	33		ARRIVO !! Centro Ippico "LA CANUNIA"	0,00